

Hexatronic Dome Closure Family

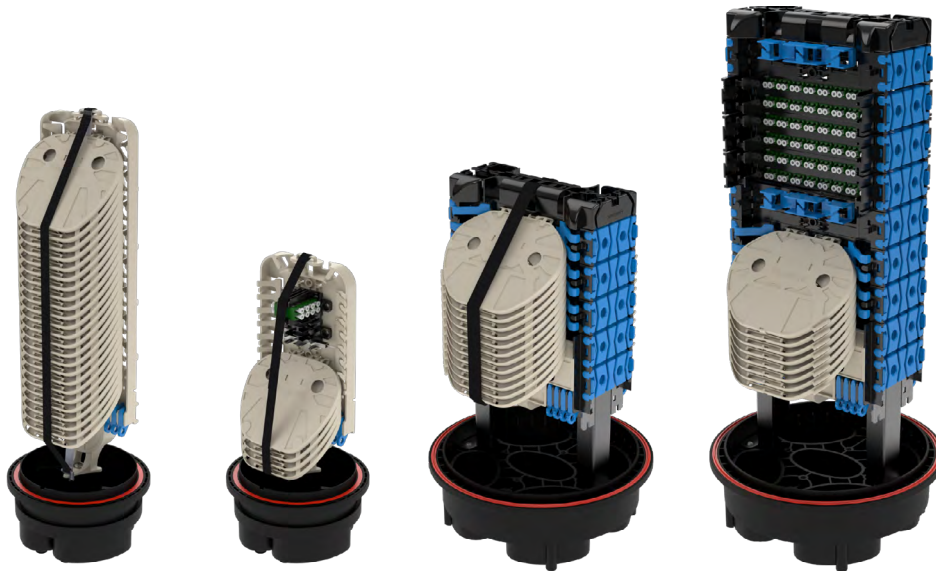



Hexatronic Dome Closure Family

- Reliable, Secure, and Versatile

Introducing the Hexatronic Dome Closure Family - offering reliability, ease of use and a secure solution to cater for all network scenarios, whether it be splicing, the use of splitters or customer connectivity.

These IP68-rated closures are designed to provide maximum splice capacity and functionality. The compact form, intelligent fibre-routing, easy access tear-out ports, and mechanical compression seals will minimise valuable time spent on site.

The Family

- The Hexatronic Dome Closure Family comes in four customisable sizes to suit any specific requirements of your network build. It's quick and straight forward installation, as well as secure maintenance features, offer a versatile modular platform providing a reliable future proof solution.

Design

- The Hexatronic Dome Closures are IP68 rated, ensuring a watertight base and dome with a clamp and integrated O-ring system that makes them perfect for use in harsh environments. They are designed with Hexatronic's key principles in mind, speed of deployment, ease of use, innovative thinking and high quality.
- Our innovative tear out port seals reduce the needs of additional time spent on site, and offer a flexible platform for multiple seal options without the requirement for special tooling or heatshrinks.

- The single-piece raceway construction is both strong and lightweight, making installation quick and easy. All closures have been designed with fibre routing in mind, to ensure they can be built to the highest standard.
- In addition to providing a safe area for midspan storage, the Hexatronic Dome Closure family offers various toolless sealing modules to fit all types and sizes of cables. The closures also features a management system for switching directions of entry fibre routes and to offer quick and easy installation of extra splice trays.
- All closures are versatile and customisable, with various accessories for holding splitters, connector assemblies, and pigtails.

Applications

The Hexatronic Dome Closures are suitable for all joining and branching applications and can also be utilised as splitter locations and customer connection points.



[Website / Datasheet](#)

Naming Convention

The Hexatronic Dome Closure family comes in four different sizes, with each size denoted by a unique naming convention.

The smaller size domes are denoted by "SHDC," which stands for "Slim Hexatronic Dome Closure." These closures are available in two sizes, SHDC-AA and SHDC-AB, with splice capacities of 144f (288f) and 288f (576f) respectively. These smaller dome closures are ideal for applications where space is limited, but high splice capacity is still required.

The larger dome closures are denoted by "LHDC," which stands for "Large Hexatronic Dome Closure." These closures are also available in two sizes, LHDC-AA and LHDC-AB, with splice capacities of 288f (576f) and 672f (1344f) respectively. These larger dome closures are perfect for applications where a higher splice capacity is needed, such as in larger network builds or installations.

SHDC



LHDC



Dome Closure Dimensions

SHDC & LHDC (measurements in mm)

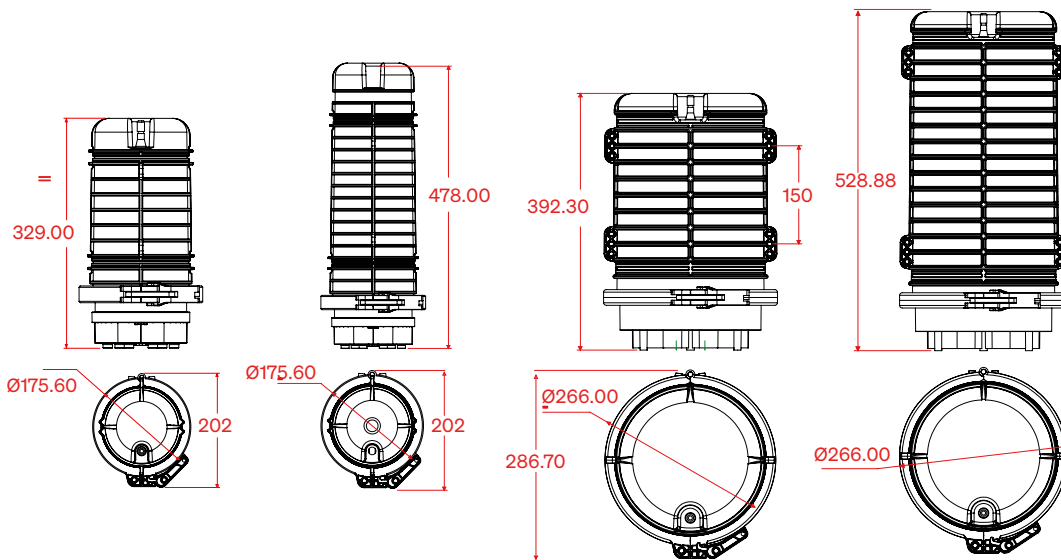

Features of the Hexatronic Dome Closure

The Hexatronic Dome Closure Range is thoughtfully designed with key features that ensure a fast and efficient installation process for your network. With over-the-top fibre routing, accessories fixings, and a large raceway, cable management becomes simplified. The included splice trays and top cover provide a secure and organised solution for splicing fibres, while the adjustable midspan with Velcro fixing points allows for flexibility in accommodating various cable sizes. The stripping point for all fibres to be 250um ensures consistency and ease of use. Tube retainers keep everything tidy and organized, while the covered mandrel allows for easy changing of fibre direction. With these features, the Hexatronic Dome Closure Range is the perfect choice for a smooth and efficient installation process, saving you time and effort.

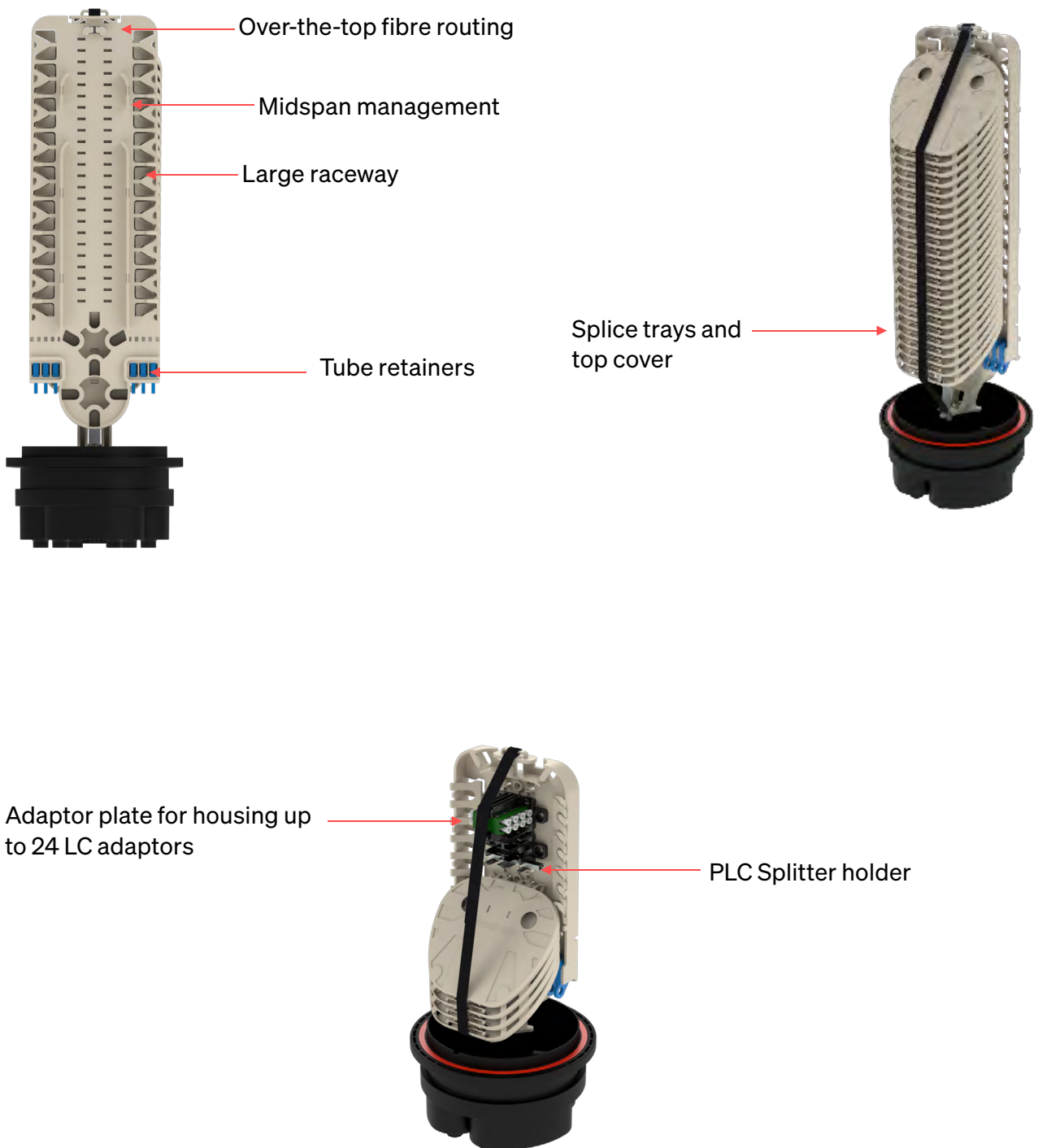

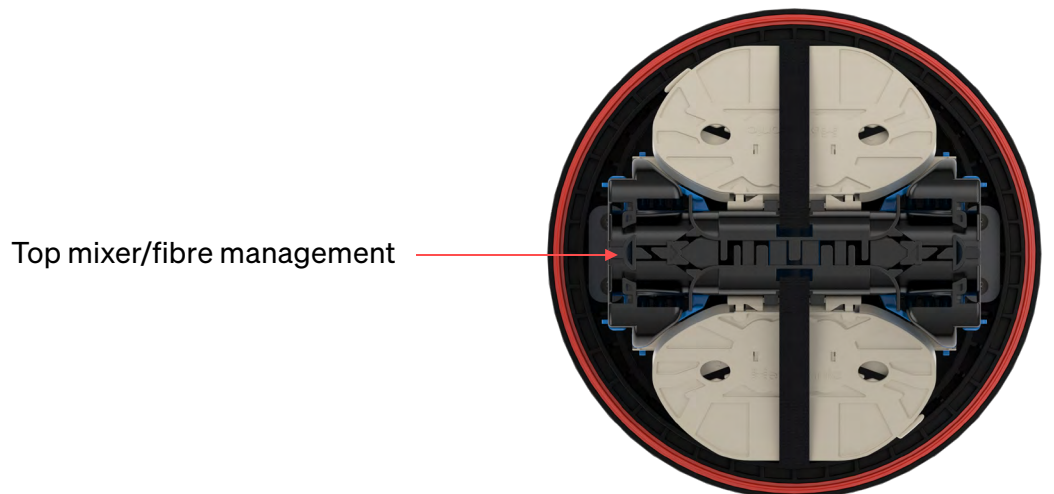
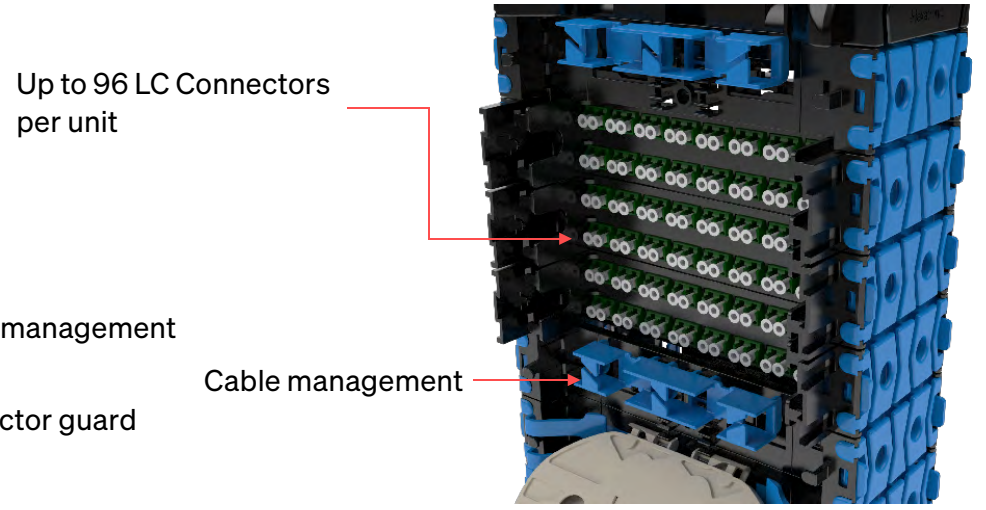
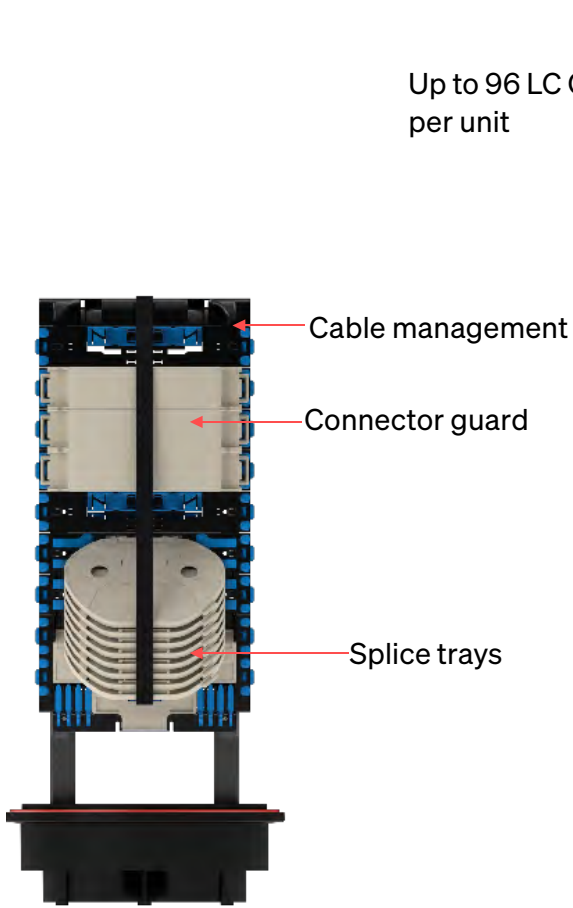
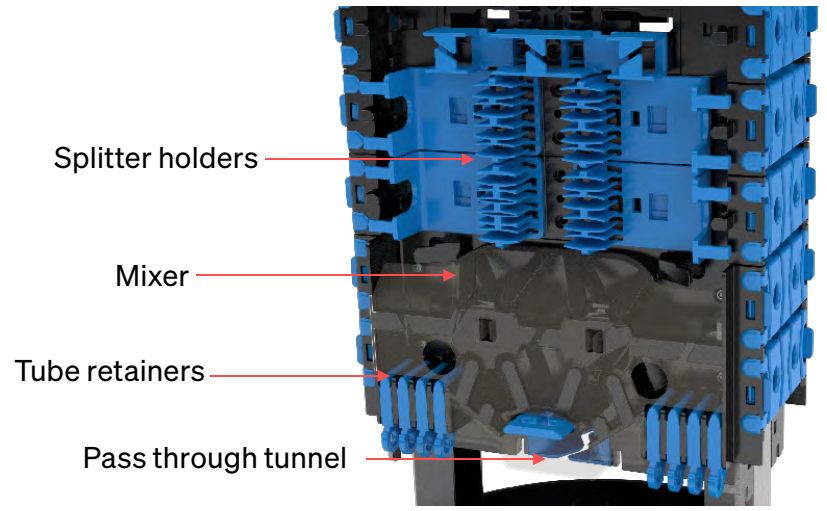
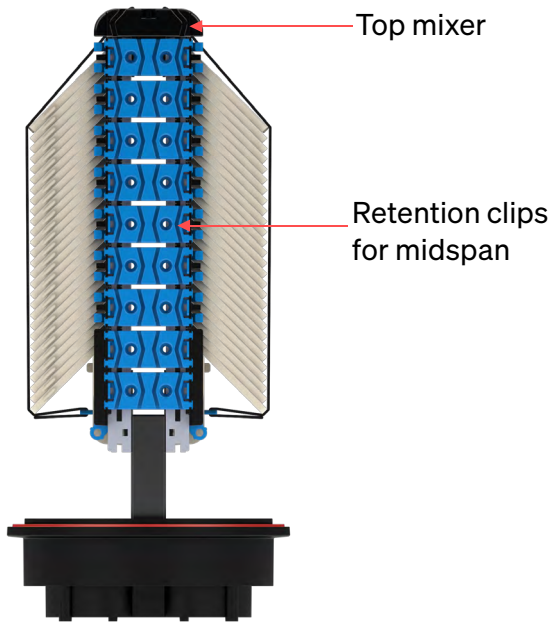

 Website / Datasheet

Product Specification Made Easy

Hexatronic understands and recognises that ordering these types of closures with multiple options can be difficult to manage, both insuring the right products have been specified and the right quantities of materials are on site when required. We have worked to create a standard prebuilt range of products to suit the majority of network requirements for both splice/branch enclosures and connectorised options. These pre-configured enclosures will allow our customers peace of mind knowing that products in the field are all built to the same specification and minimise the management of multiple part numbers.

Base Models

Splice/Branch closures

Base models	Splice Capacity (Double Stack)	Additional Tray Capacity	Bracket Inc	Port Seal Capacity
FCLD-SHDC-AA-144	144 (288)	NA	Mobra/Pole	3
FCLD-SHDC-AB-288HS	288 (576)	NA	Mobra/Pole	3
FCLD-LHDC-AA-144HS	144 (288)	288 (576)	Mobra/Pole	5
FCLD-LHDC-AA-288HS	288 (576)	NA	Mobra/Pole	5
FCLD-LHDC-AB-288HS	288 (576)	672 (1344)	Mobra/Pole	5
FCLD-LHDC-AB-576HS	576 (1152)	672 (1344)	Mobra/Pole	5
FCLD-LHDC-AB-672HS	672 (1344)	NA	Mobra/Pole	5

Base Models

Connectorised closures

Base models	Splice Capacity (double stack)	Bracket Inc	Port Seal Capacity	LC/APC Ports	Pigtails	Splitters
FCLD-SHDC-AA-P12-ALC-LD	48 (96)	Mobra/Pole	3	12	12x G657A1	
FCLD-SHDC-AA-P24-ALC-LD	48 (96)	Mobra/Pole	3	24	24x G657A1	
FCLD-SHDC-AA-P08-ALC-1x8	48 (96)	Mobra/Pole	3	8		1x 1:8
FCLD-SHDC-AA-P16-ALC-1x8	48 (96)	Mobra/Pole	3	16		2x 1:8
FCLD-SHDC-AA-P24-ALC-1x8	48 (96)	Mobra/Pole	3	24		3x 1:8
FCLD-LHDC-AB-P024-ALC-LD	96 (192)	Mobra/Pole	5	24	24x G657A1	
FCLD-LHDC-AB-P032-ALC-LD	96 (192)	Mobra/Pole	5	32	32x G657A1	
FCLD-LHDC-AB-P048-ALC-LD	96 (192)	Mobra/Pole	5	48	48x G657A1	
FCLD-LHDC-AB-P096-ALC-LD	96 (192)	Mobra/Pole	5	96	96x G657A1	

Closure Accessories

The Base

- Adding cable entry ports could not be simpler with Hexatronic's toolless design. No special tools are required - simply peel out the seal and clean up any sharp edges with the emery paper supplied in the seal kit. It's quick, easy, and hassle-free, ensuring a smooth and efficient installation process.
- All cable entry ports are the same size but various glands can be installed for different cable diameters and solutions.
- Seals for tubes are push through, no plug required unless the port has been opened
- The base of our SHDC will accept up to 3 port sealing kits and the base of our LHDC will accept up to 5.

Peelable cable entry ports

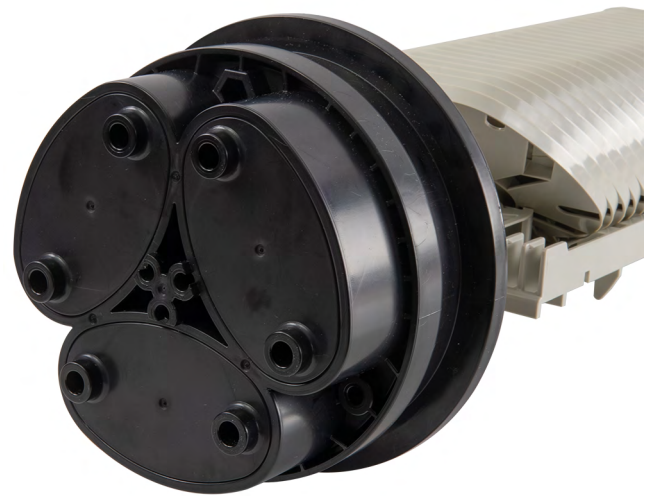

Part number	Sealing type	Cable Management Capacity		
		Max cable number	Cable range (min-max)	Midspan
FCLD-XHDCKIT-CCSO-24x6	Mechanical compression	24	4-6	No
FCLD-XHDCKIT-CCSO-12x6	Mechanical compression	12	3-6	Yes
FCLD-XHDCKIT-CCSO-4x7	Mechanical compression	4	4-7	Yes
FCLD-XHDCKIT-CCSO-4x10	Mechanical compression	4	7-10	Yes
FCLD-XHDCKIT-CCSO-2x13	Mechanical compression	2	10-13	Yes
FCLD-XHDCKIT-CCSO-2x16	Mechanical compression	2	13-16	Yes
FCLD-XHDCKIT-CCSO-2x19	Mechanical compression	2	16-19	Yes
FCLD-XHDCKIT-CCSO-2x22	Mechanical compression	2	19-22	Yes
FCLD-XHDCKIT-CCSO-12x5-1M	Mechanical compression	12x pre-installed 5/2.5mm 1m duct tails	N/A	No
FCLD-XHDCKIT-CCSO-24x5-1M	Mechanical compression	24x pre-installed 5/2.5mm 1m duct tails	N/A	No

FRP anchor point used with fixing

Gland base lip stops the gland going to far into the closure

Cable restraining point for cable tie



Optional Accessories

Part number	Description
FCLD-LHDC-KIT-CASS-48	Large Enclosure Splice Cassette Raceway Module Kit (4 trays = 48f splices)
FCLD-LHDC-KIT-CASS-PLC	Large Enclosure Splitter Cassette Raceway Module Kit (4 trays = 8 splitters)
FCLD-LHDCKIT-WMB	Large Hex Dome Closure Wall mounting bracket
FCLD-SHDCKIT-WMB	Slim Hex Dome Closure Wall mounting bracket
FCLD-LHDC-KIT-PLC-STR-B	Large Enclosure Splitter Module Storage Kit B
FCLD-LHDC-KIT-PLC-STR-C	Large Enclosure Splitter Module Storage Kit C
FCLD-SHDC-SPLITTER-HOLDER	Splitter Holder for Slim Hex Dome
FPCS-BPS0F0-102-PIG-3-2	Splitters, De-ribbonised, 250um, PLC 1:2, Unterminated, 3m G657A1
FPCS-BPS0F0-104-PIG-3-2	Splitters, De-ribbonised, 250um, PLC 1:4, Unterminated, 3m G657A1
FPCS-BPS0F0-108-PIG-3-2	Splitters, De-ribbonised, 250um, PLC 1:8, Unterminated, 3m G657A1
FPCS-BPS1F1-108-ALC-2-C60	SPLITTER PLC - 900um - 1x8 - ALC/ALC - 2m/60cm, Grade B
FPCS-BPS1F1-104-ALC-2-C60	SPLITTER PLC - 900um - 1x4 - ALC/ALC - 2m/60cm, Grade B
FPCS-BPS1F1-116-ALC-2-C60	SPLITTER PLC - 900um - 1x16 - ALC/ALC - 2m/60cm, Grade B

*Other accessories available on request, including full range of MOBRA kits.

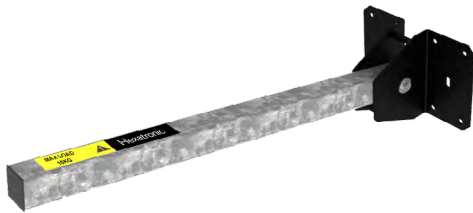



Hexatronic creates sustainable networks worldwide.
We cooperate with customers on four continents –
from telecom operators to network owners – and offer
leading, high-class fiber solutions for all conceivable
areas of use.

hexatronic.com/en-uk



Revision 1.0